

MODEL	CODICE ATIM	Description	M	P min	H min	S1	E	Z min	S min	Цена с ДДС
SIESTA	411/78.1155.T	Mechanism + cover caps	450	550	120	15/20	750	405	16	830.34
SIESTA	411/78.1150.T	Mechanism + cover caps	600	550	120	15/20	750	555	16	830.34
SIESTA	411/78.1160.T	Mechanism + cover caps	900	550	120	15/20	750	855	16	830.34
SIESTA	411/78.1170.T	Mechanism + cover caps	1200	550	120	15/20	750	1155	16	830.34
<i>Measures expressed in millimetres</i>										

Video: <https://youtu.be/VqXFaeCm6Qg>

Img:



Technical drawing:

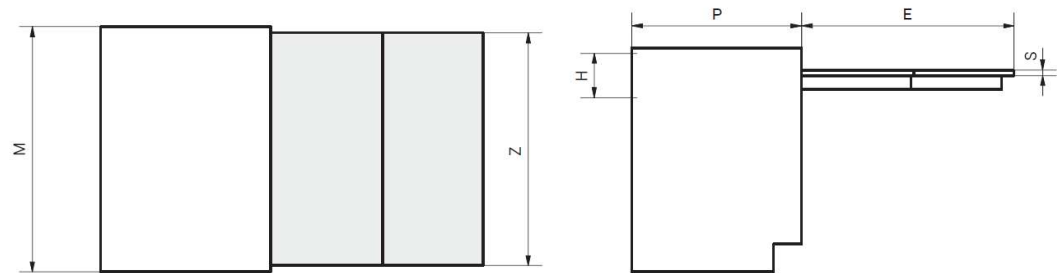

MODEL	CODICE ATIM	Description	M	P min	H min	S1	E	Z min	S min	Цена с ДДС
BRUNCH	411/78.1100.T	Mechanism + cover caps	600	540	120	15/20	1060	555	16	1,621.68
BRUNCH	411/78.1110.T	Mechanism + cover caps	900	540	120	15/20	1060	855	16	1,621.68
BRUNCH	411/78.1120.T	Mechanism + cover caps	1200	540	120	15/20	1060	1155	16	1,621.68
<i>Measures expressed in millimetres</i>										

Video: <https://youtu.be/hJWGP63e2H4>

Img:



Technical drawing:

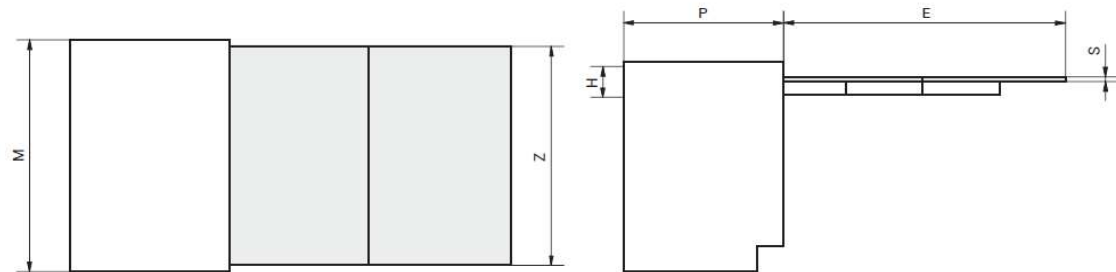

MODEL	CODICE ATIM	Description	M	P min	H min	S1	E	Z min	S min	Цена с ДДС
COCKTAIL	411/78.1155.ET	Mechanism + cover caps	450	540	120	15/20	753	405	16	691.55
COCKTAIL	411/78.1150.ET	Mechanism + cover caps	600	540	120	15/20	753	555	16	691.55
COCKTAIL	411/78.1160.ET	Mechanism + cover caps	900	540	120	15/20	753	855	16	691.55
COCKTAIL	411/78.1170.ET	Mechanism + cover caps	1200	540	120	15/20	753	1155	16	691.55

Measures expressed in millimetres

Video: <https://youtu.be/Ae-l2-r6LS8>

Img:



Technical drawing:

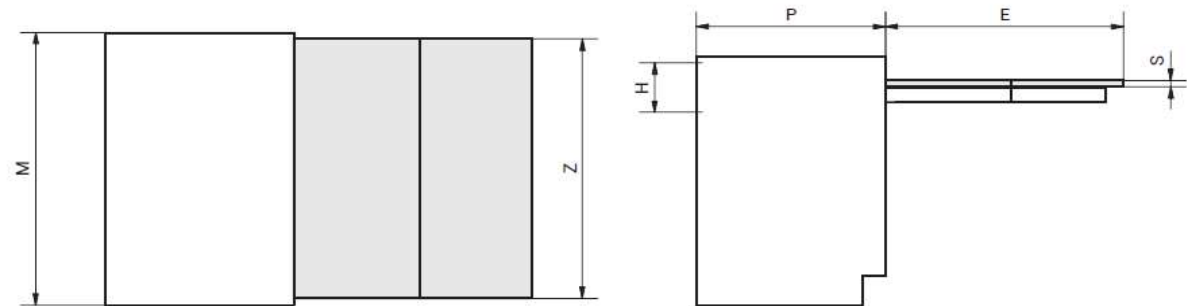

MODEL	CODICE ATIM	Description	M	P min	H min	S1	E	Z min	S min	Цена с ДДС
LUNCH	411/78.1120.ET	Mechanism + cover caps	450-1200	540	120	15/31	895	1155	16	696.66
<i>Measures expressed in millimetres</i>										

Video: <https://youtu.be/dhJVjVSncI>

Img:



Technical drawing:

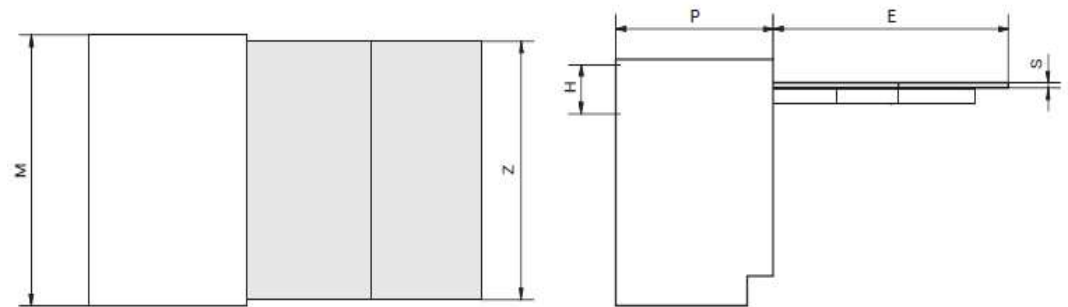

MODEL	CODICE ATIM	Description	M	P min	H min	S1	E	Z min	S min	Цена с ДДС	Equipment
LUNCH REVERSE	411/78.1105.RT	Mechanism + cover caps	450	540	120	15/20	1045	405	16	787.41	Without wood panel
LUNCH REVERSE	411/78.1100.RT	Mechanism + cover caps	600	540	120	15/20	1045	555	16	787.41	Without wood panel
LUNCH REVERSE	411/78.1110.RT	Mechanism + cover caps	900	540	120	15/20	1045	855	16	787.41	Without wood panel
LUNCH REVERSE	411/78.1120.RT	Mechanism + cover caps	1200	540	120	15/20	1045	1155	16	787.41	Without wood panel
<i>Measures expressed in millimetres</i>											

Video: <https://youtu.be/WBlbfJntW3o>

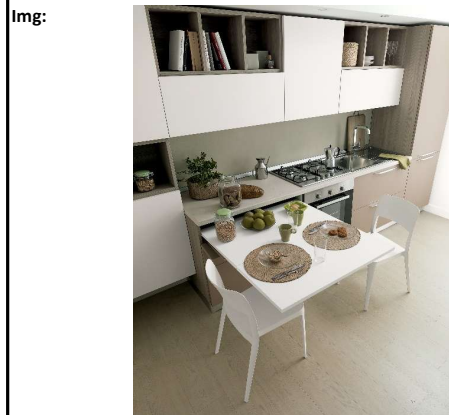

Technical drawing:

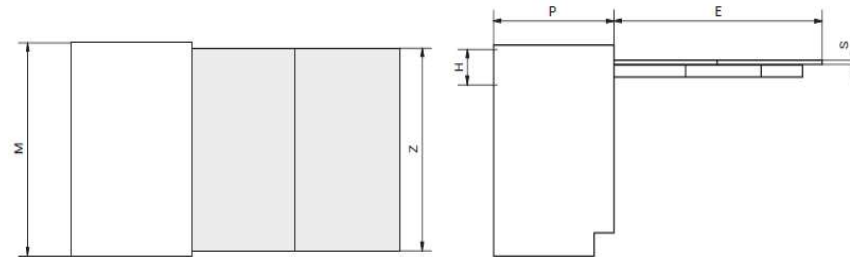

MODEL	CODICE ATIM	Description	M	P min	H min.	S1	E	Z	S min	Цена с ДДС	Equipment
SHOT	411/78.1130.T	Mechanism + cover caps	450/1200	560	90	15/20	490	405/1155	16	574.81	Without wood panel

Measures expressed in millimetres

Video: <https://youtu.be/ORx7GGKVu-8>

Img:



Technical drawing:

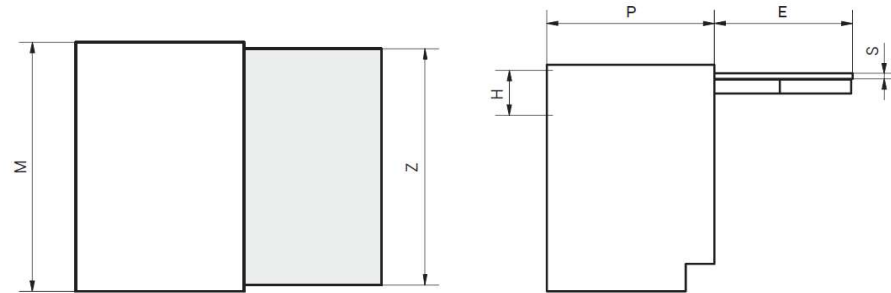

MODEL	CODICE ATIM	Description	M	P min	H min.	S1	E	Z	S min	Цена с ДДС
DESK	411/78.0005.02	Mechanism	450	150	200	15/20	350	445	18	915.20
COPPIA COVER DESK nero	2.5541204.10	Cover black								66.02
COPPIA COVER DESK bianco	2.5541204.12	Cover white								66.02
<i>Measures expressed in millimetres</i>										

Video: <https://youtu.be/QE2PoY17yp0>

Img:



Technical drawing:

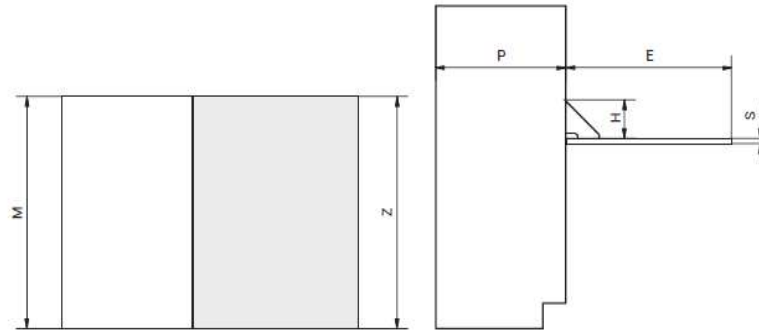

MODEL	CODICE ATIM	Description	M	P min	H min	S1	E	Z min	S	ST	Цена с ДДС
OPLA'	411/78.1700.T	Mechanism + cover caps	450	540	75	15/24	500	405	15/20	15/20	749.94
OPLA'	411/78.1710.T	Mechanism + cover caps	600	540	75	15/25	500	555	15/20	15/20	749.94
OPLA'	411/78.1720.T	Mechanism + cover caps	900	540	75	15/26	500	855	15/20	15/20	749.94
OPLA'	411/78.1730.T	Mechanism + cover caps	1200	540	75	15/27	500	1155	15/20	15/20	749.94

Measures expressed in millimetres

Video: <https://youtu.be/aCeZMo43dhM>

Img:



Technical drawing:

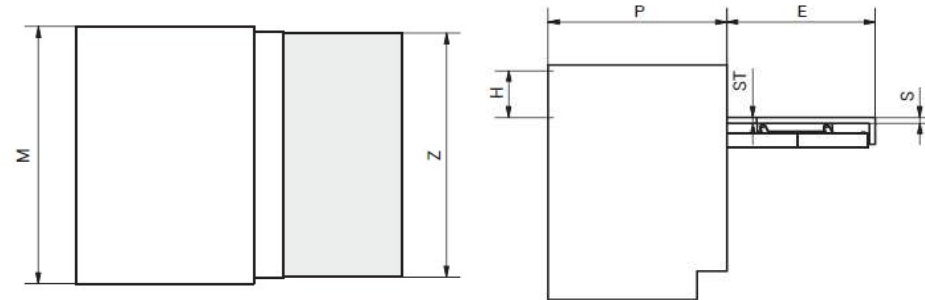

MODEL	CODICE ATIM	Description	M	P min	H min	S1	E	Z min	S	Цена с ДДС
OPLA' FOLDING	78.1720.FT	Mechanism + cover caps	1200	540	205	18	500	1155	18	955.92
<i>Measures expressed in millimetres</i>										

Video: <https://youtu.be/G2mNNWhJ6hA>

Img:



Technical drawing:

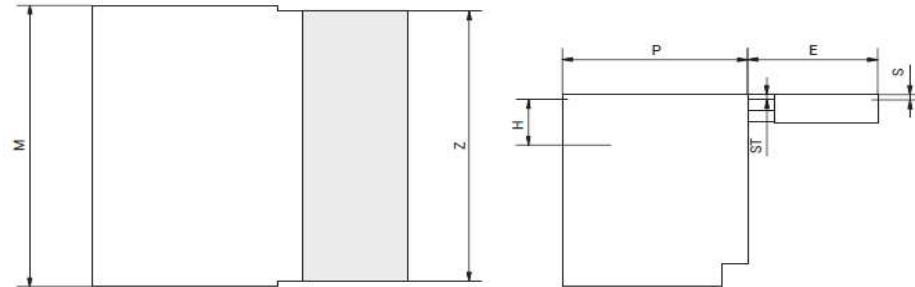

MODEL	CODICE ATIM	Description	M	P min	H min	S1	E	Z min	S	Цена с ДДС
HOMEWORK	411/78.1200.T	Mechanism + cover caps	600	540	54	15/20	1100	555	16	1,017.55
HOMEWORK	411/78.1210.T	Mechanism + cover caps	900	540	54	15/20	1100	855	16	1,017.55
HOMEWORK	411/78.1220.T	Mechanism + cover caps	1200	540	54	15/20	1100	1155	16	1,017.55
<i>Measures expressed in millimetres</i>										

Video: <https://youtu.be/hJMrfVOJhI4>

Img:

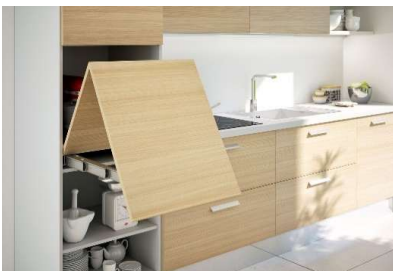

Technical drawing:

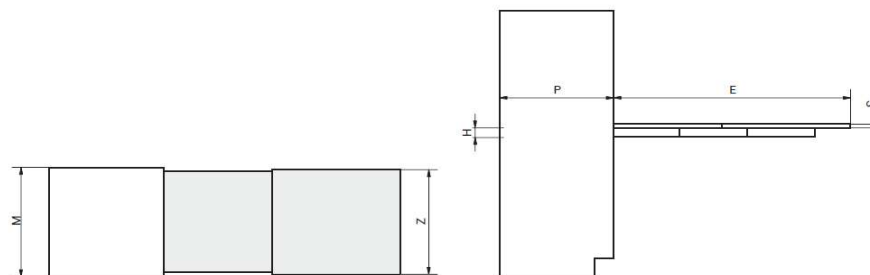

MODEL	CODICE ATIM	Description	M	P	H min	S1	E	Z	S MIN	Цена с ДДС
COOK	78.1490.25	Mechanism + cover cap + wodden box	600	520	120	15/20	720	555	18	1,994.97
COOK	78.1491.25	Mechanism + cover cap + wodden box	900	520	120	15/20	720	855	18	2,695.54
COOK	78.COOK.T	Mechanism + cover cap		520	120	15/20	720	555	18	805.39
<i>Measures expressed in millimetres</i>										

Img:



Technical drawing:

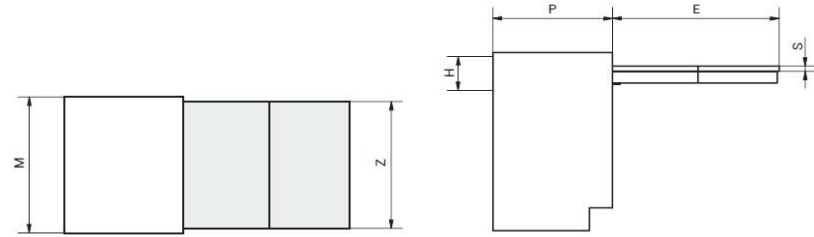

MODEL	CODICE ATIM	Description	M	P	H min	S1	E	Z min	S min	Цена с ДДС
FUNCTIONAL	78.1493.25	Mechanism + cover cap + wodden box	600	450	110	15/20	350	555	16	1,463.84
FUNCTIONAL	78.1494.25	Mechanism + cover cap + wodden box	900	450	110	15/20	350	855	16	1,934.39
FUNCTIONAL	78.1493.T	Mechanism + cover cap	600	450	110	15/20	350	555	16	574.31
FUNCTIONAL	78.1494.T	Mechanism + cover cap	900	450	110	15/20	350	855	16	574.31
<i>Measures expressed in millimetres</i>										

Img:



Technical drawing:

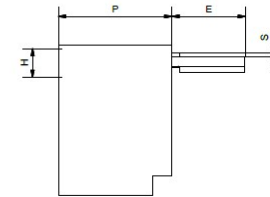
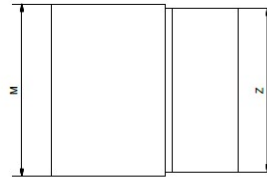

MODEL	CODICE ATIM	Description	P	H min	S1	E	Z min	S min	Цена с ДДС
BLADE	78.1492.PV	Mechanism + Basket + Top + Tray	560	120	16 - 19	500	555	20	1,572.53
<i>Measures expressed in millimetres</i>									

Img:



Technical drawing:

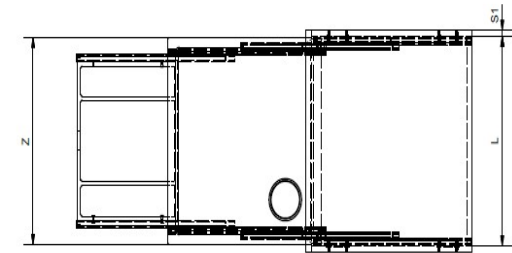
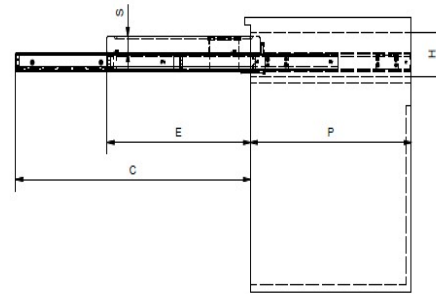

MODEL	CODICE ATIM	Description	M	P	H min	S1	E	Z	S min	Цена с ДДС
BASKET K	78.1497.T	Mechanism + cover caps	450	450	690	15/20	350	405	16	616.75
BASKET K	78.1498.T	Mechanism + cover caps	600	450	690	15/20	350	555	16	623.04
<i>Measures expressed in millimetres</i>										

Img:

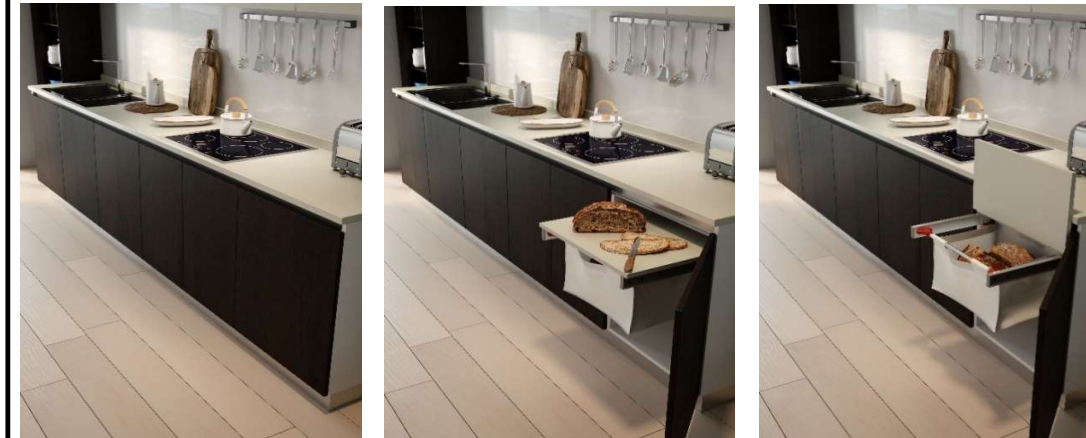

Technical drawing:

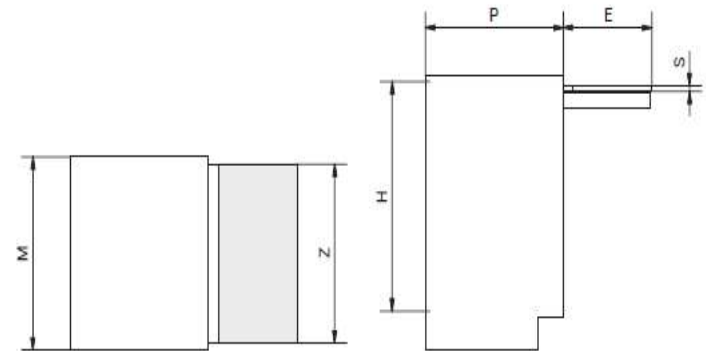

MODEL	CODICE ATIM	Description	M	P min	H min.	S1	E	Z min	S	Цена с ДДС
ZIP	411/78.1260.22	Mechanism + cover caps	450	550	120	15/20	900	405	18	1,974.96
ZIP	411/78.1261.22	Mechanism + cover caps	600	550	120	15/20	900	555	18	1,974.96
ZIP	411/78.1262.22	Mechanism + cover caps	900	550	120	15/20	900	855	18	1,974.96
<i>Measures expressed in millimetres</i>										

Img:



Technical drawing:

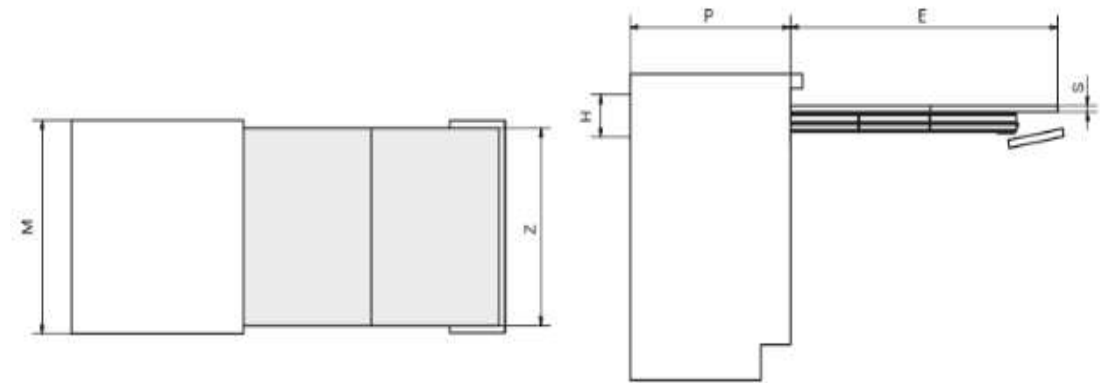

MODEL	CODICE ATIM	Description	M	P min	H min.	S1	E	Z min	S	Цена с ДДС
READY	411/78.1140.T	Mechanism + cover caps	450	500	170	15/20	800	405	16/18	1,292.65
READY	411/78.1141.T	Mechanism + cover caps	600	500	170	15/20	800	555	16/18	1,292.65
READY	411/78.1142.T	Mechanism + cover caps	900	500	170	15/20	800	855	16/18	1,292.65

Measures expressed in millimetres

Img:



Technical drawing:

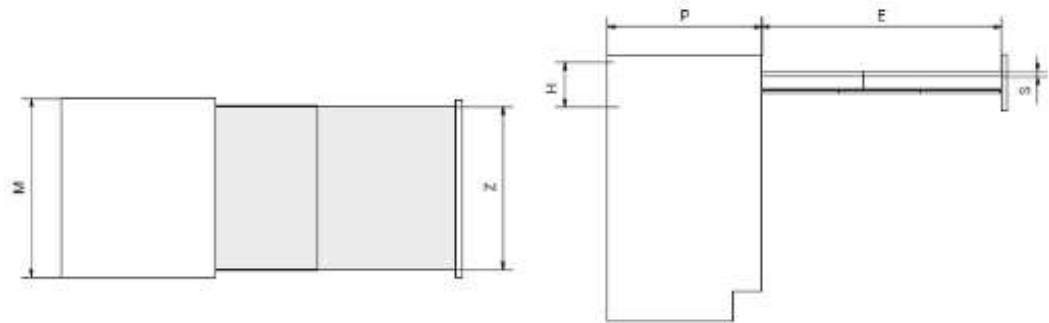

MODEL	CODICE ATIM	Description	M	P min	H min	S1	E	Z min	S min	T	Цена с ДДС
T-ABLE	411/78.1900.T	Mechanism + cover caps	600	540	120	15/26	900	555	16	745/840	1,127.84
T-ABLE	411/78.1910.T	Mechanism + cover caps	900	540	120	15/27	900	855	16	745/840	1,247.84
T-ABLE	411/78.1920.T	Mechanism + cover caps	1200	540	120	15/28	900	1155	16	745/840	1,247.84
<i>Measures expressed in millimetres</i>											

Video: https://youtu.be/YJ8tCO_aJds

Img:



Technical drawing:

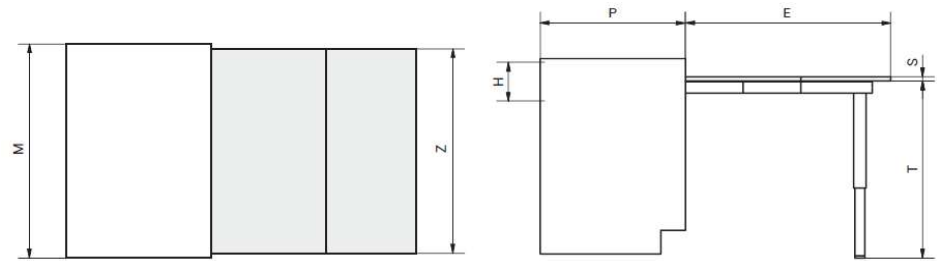

MODEL	CODICE ATIM	Description	M	P min	H min	S1	E	Z min	S min	T	Цена с ДДС
T-ABLE XL	411/78.1900.XT	Mechanism + cover caps	600	520	150	15/20	1316	555	16	700/795	1,316
T-ABLE XL	411/78.1910.XT	Mechanism + cover caps	900	520	150	15/20	1317	855	16	700/795	1,436
T-ABLE XL	411/78.1920.XT	Mechanism + cover caps	1200	520	150	15/20	1318	1155	16	700/795	1,436

Measures expressed in millimetres

Video: <https://youtu.be/JSEFJSiw1nI>

Img:



Technical drawing:

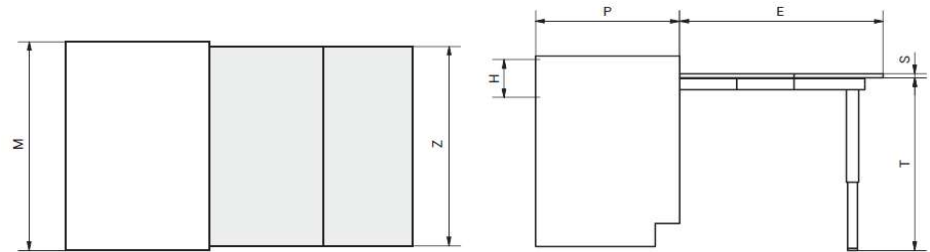

MODEL	CODICE ATIM	Description	M	H min.	S1 min	T	E	Z min	S min	Цена с ДДС	Note
JUST	411/78.1990.25	Mechanism	600	80	40	855	750	600	18	527.46	
JUST	411/78.1990.25 P	Mechanism	600	80	40	855	750	600	18	656.05	with gas piston
<i>Measures expressed in millimetres</i>											

Img:



Technical drawing:

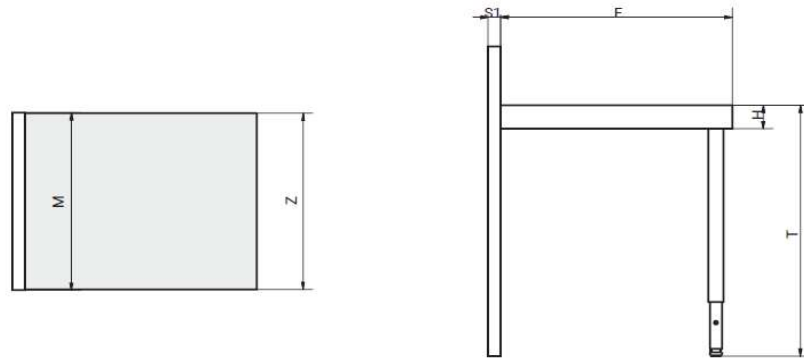

MODEL	CODICE ATIM	Description	L module	P min	H min	S1	E	Z min	S min	T	Цена с ДДС
T-BENCH	411/78.1950.T	Mechanism + cover caps	450	540	120	15/24	874	405	20	385/414	1,071.50
T-BENCH	411/78.1960.T	Mechanism + cover caps	600	540	120	15/25	875	555	21	385/415	1,071.50

Measures expressed in millimetres

Video: <https://youtu.be/g-Dxn9KFHvI>

Img:



Technical drawing:

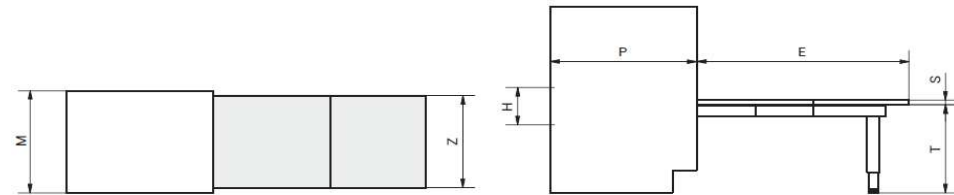

MODEL	CODICE ATIM	L module	Description	P min	H min	S1	E	Z min	S min	T	Цена с ДДС
T-BENCH XL	411/78.1960.XT	mm 600	Mechanism + cover caps	520	150	15/20	1310	555	16	385/410	1,303.09
<i>Measures expressed in millimetres</i>											

Video: <https://youtu.be/g-Dxn9KFHvI>

Img:



Technical drawing:

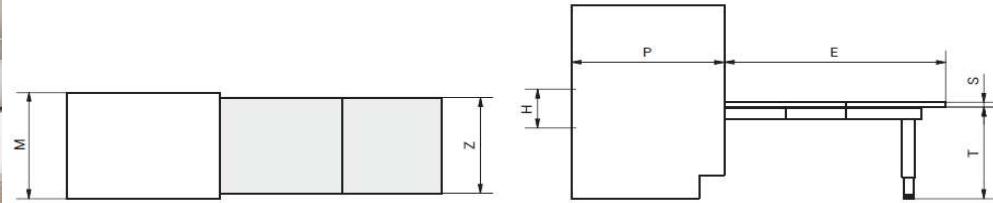

MODEL	CODICE ATIM	Description	M	P min	H min	S1	E	Z min	S min	T	Цена с ДДС
PARTY	411/78.1500.T	Mechanism + cover caps	600	560	150	16/19	1380	557	16	725/820	2,130.91
PARTY	411/78.1510.T	Mechanism + cover caps	900	560	150	16/19	1380	857	16	725/820	2,130.91
PARTY	411/78.1520.T	Mechanism + cover caps	1200	560	150	16/19	1380	1157	16	725/820	2,130.91

Measures expressed in millimetres

Video: <https://youtu.be/m9pYXTsah5M>

Img:



Technical drawing:

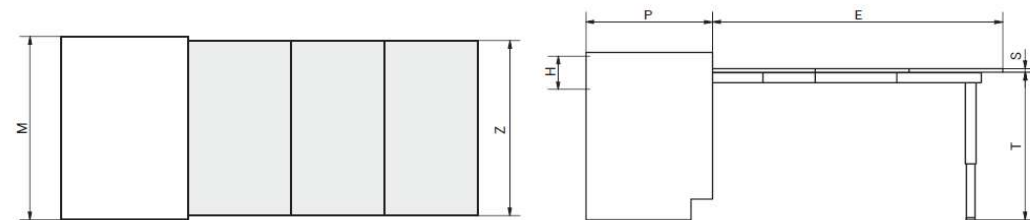

MODEL	CODICE ATIM	Description	L module	P min	H min	S1	E	Z min	S	T	Цена с ДДС
MENSOLA PARTY	411/78.1601.T	Mechanism + cover caps	600	502	140	18.5	1540	555	14	730/755	2,261.82
MENSOLA PARTY	411/78.1602.T	Mechanism + cover caps	900	502	140	18.5	1540	855	14	730/755	2,261.82
MENSOLA PARTY	411/78.1600.T	Mechanism + cover caps	1200	502	140	18.5	1540	1155	14	730/755	2,261.82
<i>Measures expressed in millimetres</i>											

Video: <https://youtu.be/m9pYXTsah5M>

Img:



Technical drawing:

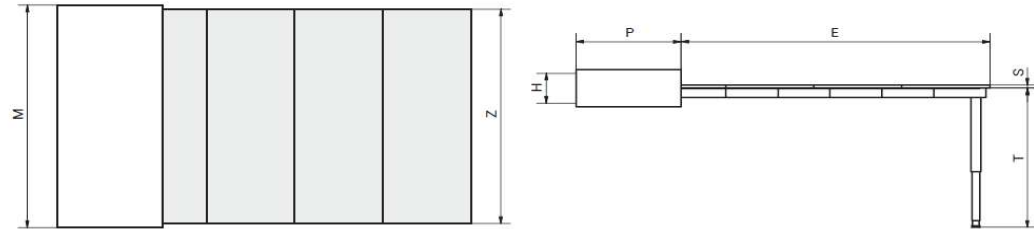

MODEL	CODICE ATIM	Description	M	P min	H min	S1	E	Z min	S min	T	Цена с ДДС
EVOLUTION	411/78.1610.T	Mechanism + cover caps	600	520	120	15/20	1040	555	16	730/755	1,551.87
EVOLUTION	411/78.1611.T	Mechanism + cover caps	900	520	120	15/20	1040	855	16	730/755	1,551.87
EVOLUTION	411/78.1612.T	Mechanism + cover caps	1200	520	120	15/20	1040	1155	16	730/755	1,551.87

Measures expressed in millimetres

Video: <https://youtu.be/FcpuaAAbTrI>

Img:



Technical drawing:

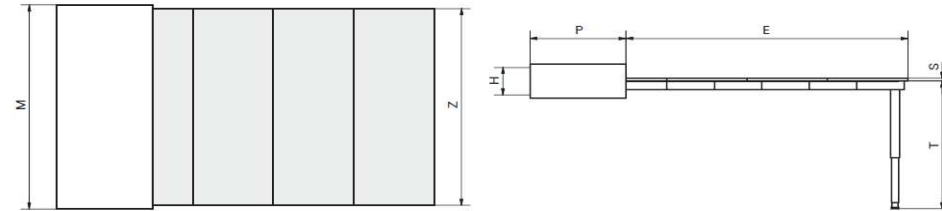

MODEL	CODICE ATIM	Description	M	P min	H min	S1	E	Z min	S min	T	Цена с ДДС
EVOLUTION XL	411/78.1620.T	Mechanism + cover caps	600	520	120	15/20	1520	555	16	730/755	1,843.60
EVOLUTION XL	411/78.1621.T	Mechanism + cover caps	900	520	120	15/20	1520	855	16	730/755	1,843.60
EVOLUTION XL	411/78.1622.T	Mechanism + cover caps	1200	520	120	15/20	1520	1155	16	730/755	1,843.60

Measures expressed in millimetres

Video: <https://youtu.be/FcpuaAAbTrI>

Img:



Technical drawing:

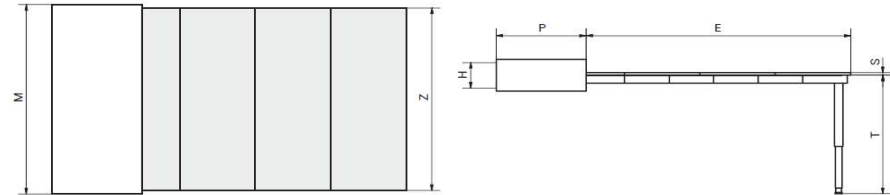

MODEL	CODICE ATIM	Description	M	P min	H min	S1	E	Z min	S	ST	Цена с ДДС
OPLA' TOP	411/78.1750.T	Mechanism + cover caps	450	540	75	15/20	500	405	20/60	20/60	869.94
OPLA' TOP	411/78.1760.T	Mechanism + cover caps	600	540	75	15/20	500	555	20/60	20/60	869.94
OPLA' TOP	411/78.1770.T	Mechanism + cover caps	900	540	75	15/20	500	855	20/60	20/60	869.94
OPLA' TOP	411/78.1780.T	Mechanism + cover caps	1200	540	75	15/20	500	1155	20/60	20/60	742.00

Measures expressed in millimetres

Video: <https://youtu.be/U4NYyWgkXGg>

Img:



Technical drawing:

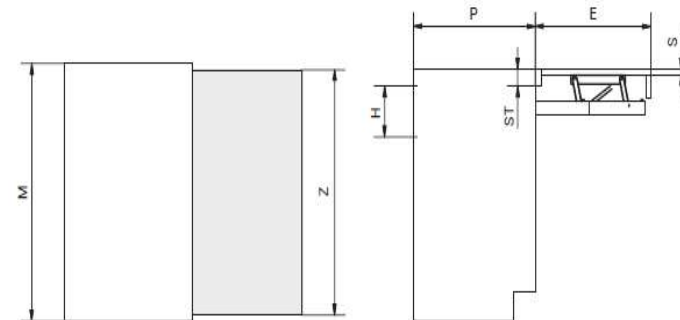

MODEL	CODICE ATIM	Description	L min	P min	H min	S	Z	E	Цена с ДДС
SANDWICH	411/78.1850.T	Mechanism + cover caps	592	540	120	18	590	510	1,130.19
SANDWICH	411/78.1860.T	Mechanism + cover caps	802	540	120	18	800	510	1,130.19
SANDWICH	411/78.1870.T	Mechanism + cover caps	1102	540	120	18	1100	510	1,130.19
<i>Measures expressed in millimetres</i>									

Video: <https://youtu.be/wSYTXfKsf0g>

Img:



Technical drawing:

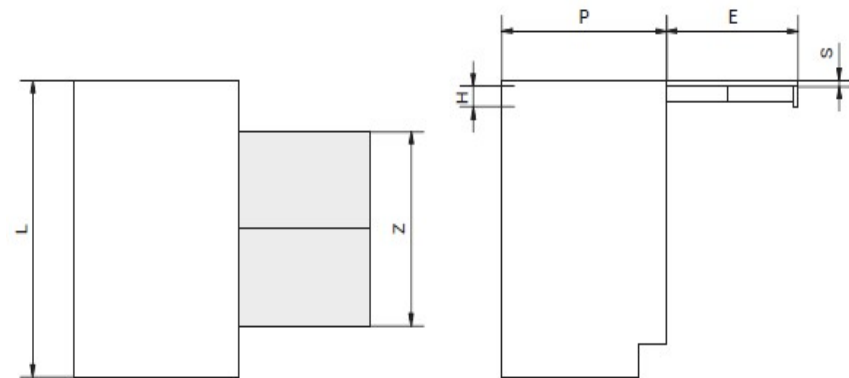

MODEL	CODICE ATIM	Description	M	P min	H min	S1	E	Z min	S min	Цена с ДДС
FLIP TOP	411/78.1800.T	Mechanism + cover caps	450	540	120	15/20	480	450	16	781.98
FLIP TOP	411/78.1810.T	Mechanism + cover caps	600	540	120	15/20	480	600	16	781.98
FLIP TOP	411/78.1820.T	Mechanism + cover caps	900	540	120	15/20	480	900	16	781.98
FLIP TOP	411/78.1830.T	Mechanism + cover caps	1200	540	120	15/20	480	1200	16	781.98

Measures expressed in millimetres

Video: <https://www.youtube.com/watch?v=EjzbdP3FH1g>

Img:



Technical drawing:

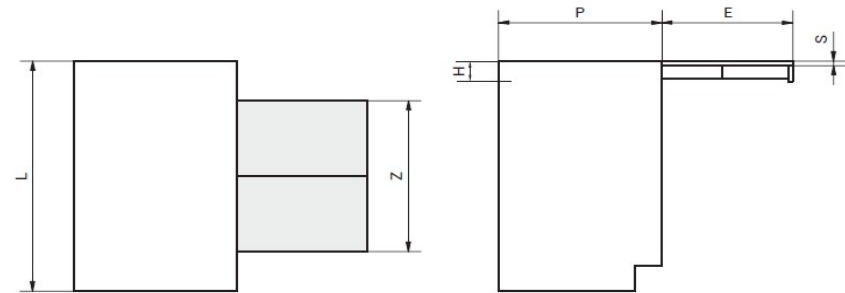

MODEL	CODICE ATIM	Description	M min	P min	H min	E	Z min	S min	Цена с ДДС
BREAKFAST	411/78.1251.T	Mechanism + cover caps	600	1780	80	1600	580	18	2,588.90
			<i>Measures expressed in millimetres</i>						

Video: <https://youtu.be/Tf-xxBkXaJl>

Video Soft Move: <https://youtu.be/wp2DdTsfio>

Img:



Technical drawing:

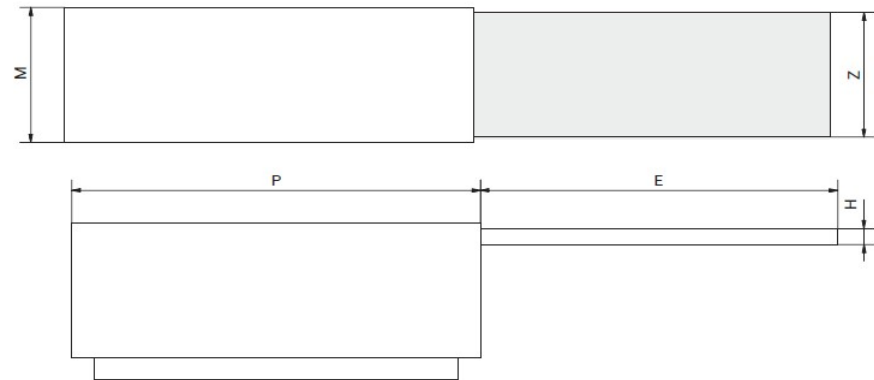

MODEL	CODICE ATIM	Description	P min	H min	Z min	E	S min	Цена с ДДС
BREAKFAST TOP	411/78.1252.T	Mechanism + cover caps	1200	85	850	900	18	2,588.89
BREAKFAST TOP	411/78.1253.T	Mechanism + cover caps	2428	85	850	1213	18	1,880.00
BREAKFAST TOP	411/78.1254.T	Mechanism + cover caps	2400	85	850	1500	18	2,588.89
BREAKFAST TOP	411/78.1255.T	Mechanism + cover caps	3000	85	850	1500	18	2,588.89
<i>Measures expressed in millimetres</i>								

Video: <https://youtu.be/YD8l25lvsFs>

Img:



Technical drawing:

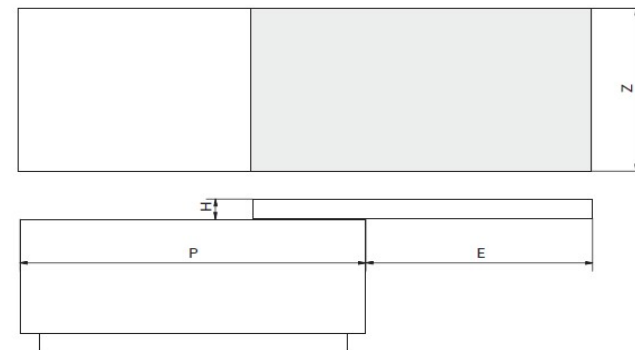

MODEL	CODICE ATIM	Description	P min	H min	Z	L	S min	E	Цена с ДДС
SLIDE QUADRATO	411/78.1241.T	Mechanism + cover caps	1200	75	1200	1200	18	350	1,823.04
SLIDE RETTANGOLARE DX	411/78.1242.T	Mechanism + cover caps	950	75	1200	950	18	350	1,700.00
SLIDE RETTANGOLARE SX	411/78.1243.T	Mechanism + cover caps	950	75	1200	950	18	350	1,823.04
SLIDE QUADRATO	411/78.1245.T	Mechanism + cover caps	900	75	900	900	18	315	1,823.04

Measures expressed in millimetres

Video: <https://youtu.be/iPROC2mN2OY>

Img:



Technical drawing:

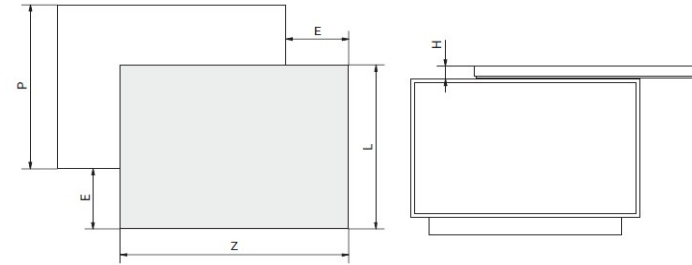

MODEL	CODICE ATIM	Description	L module	P min	H min	S1 min	E	S min	Z	Цена с ДДС
SNACK	411/78.1281.T	Mechanism + cover caps	2467	800	80	40	640	18	2460	1,389.83
SNACK	411/78.1282.T	Mechanism + cover caps	1867	800	80	40	640	18	1860	1,389.83
<i>Measures expressed in millimetres</i>										

Video: <https://youtu.be/DnBBXqMzCEc>

Img:



Technical drawing:

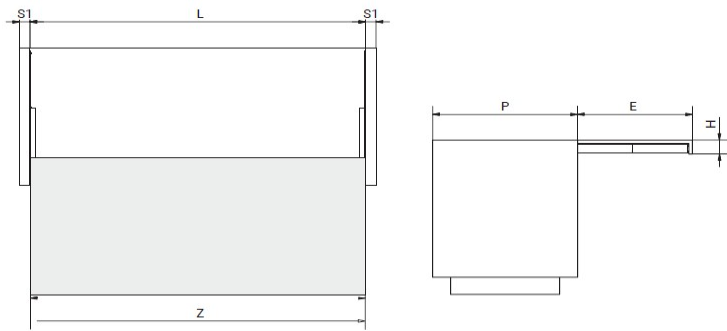

MODEL	CODICE ATIM	Description	L module	Z min	L min	E	H min.	S min	Цена с ДДС
SNACK TOP	411/78.1283.22	Mechanism	900	900	900	500	65	18	1,434.19
SNACK TOP	411/78.1284.22	Mechanism	1200	1200	1200	650	65	18	1,644.84
SNACK TOP AIR SELF CLOSING	411/78.1283.22 A	Mechanism	900	900	900	500	65	18	1,616.55
SNACK TOP AIR SELF CLOSING	411/78.1284.22 A	Mechanism	1200	1200	1200	650	65	18	1,827.19
<i>Measures expressed in millimetres</i>									

Video: <https://youtu.be/SojUP7Hu318>

Img:



Technical drawing:

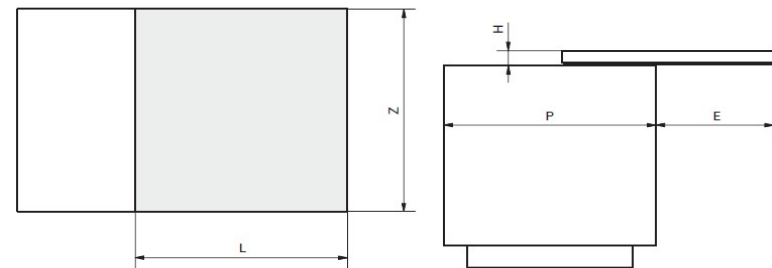

MODEL	CODICE ATIM	Description	P min	H min	E	L max	Z	T	Цена с ДДС
FLAP	411/78.1244.22	Mechanism	950	55	600	600/1300	950	450	1,788.76
FLAP	411/78.1244.22 C	Mechanism	950	55	300	600/1300	950	450	1,788.76
<i>Measures expressed in millimetres</i>									

Video: <https://youtu.be/S3t-Dldr9qU>

Img:



Technical drawing:

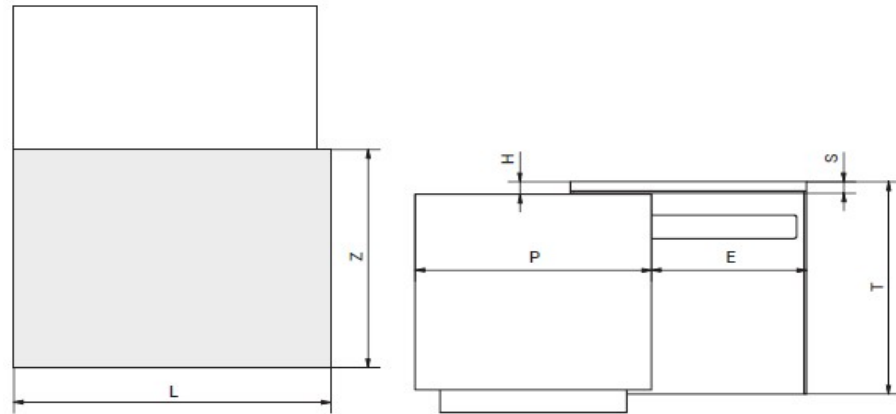

MODEL	CODICE ATIM	Description	P min	L	Z	E	Цена с ДДС
CORNER 1200X1200	78.1230.T	Mechanism + cover caps	1200	1200	1200	350	1,332.83
CORNER 1200X900 RIGHT	78.1231.T	Mechanism + cover caps	900	1200	1200	350	1,332.83
CORNER 1200X900 LEFT	78.1232.T	Mechanism + cover caps	900	1200	1200	350	1,332.83
CORNER 900X900	78.1233.T	Mechanism + cover caps	900	900	900	300	1,332.83
CORNER 900X600 RIGHT	78.1234.T	Mechanism + cover caps	600	900	900	300	1,332.83
CORNER 900X600 LEFT	78.1235.T	Mechanism + cover caps	600	900	900	300	1,332.83
<i>Measures expressed in millimetres</i>							

Img:



Technical drawing:

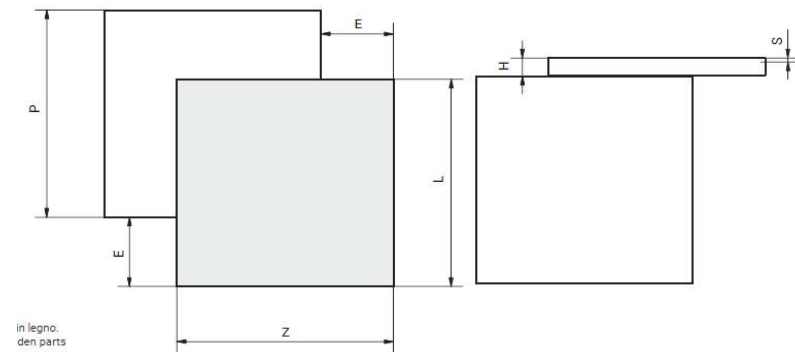

MODEL	CODICE ATIM	Description	P min	H min	Z min	M max	S min	E max	Цена с ДДС
TWICE	78.1480.T	Mechanism + cover caps	600	80	600	1200	18	600	1,333.58
<i>Measures expressed in millimetres</i>									

Img:



Technical drawing:

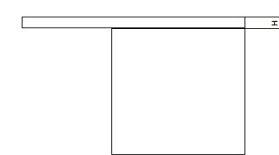
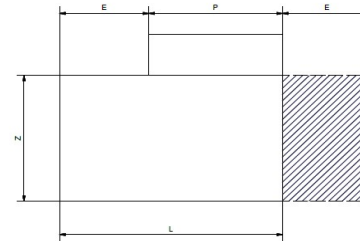

MODEL	CODICE ATIM	Description	P	H min	Z min	L	S min	E	Цена с ДДС
TWICE TOP	78.1470.T	Mechanism + cover caps	900	80	900	1500	18	600	1,537.95
TWICE TOP	78.1471.T	Mechanism + cover caps	1200	80	900	1500	18	600	1,537.95
<i>Measures expressed in millimetres</i>									

Img:



Technical drawing:

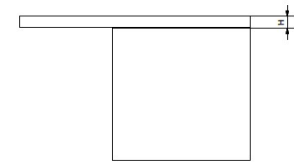
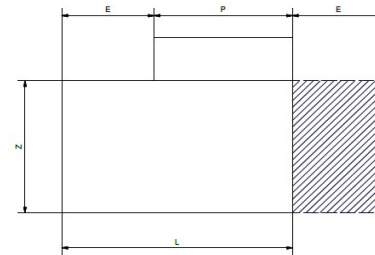

MODEL	CODICE ATIM	Description	P	H min	Z min	L	S min	E	Цена с ДДС
TOP 33	411/78.1270.22	Mechanism	900	45	1800	900	12	610	2,081.86
TOP 33	411/78.1271.22	Mechanism	1200	45	1800	1200	12	710	2,081.86
<i>Measures expressed in millimetres</i>									

Img:



Technical drawing:

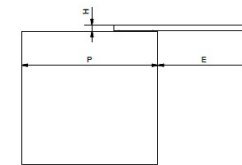
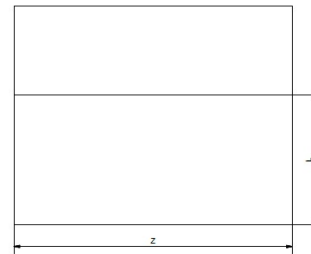

MODEL	CODICE ATIM	Description	M	P min	E	Z	S	ST	T	Gamba/Leg	Цена с ДДС
VOILA'	411/78.1190.T	Mechanism + cover caps	900	660	570	900	20/40	20/40	865/890	60x60	2167.69
VOILA'	411/78.1194.25	Mechanism	800	660	570	800	20/40	20/40	865/890	60x60	2149.58
VOILA'	411/78.1195.25	Mechanism	955	660	570	955	20/40	20/40	865/890	60x60	2149.58
<i>Measures expressed in millimetres</i>											

Video: <https://youtu.be/sgJ5q4VIngE>

Img:



Technical drawing:

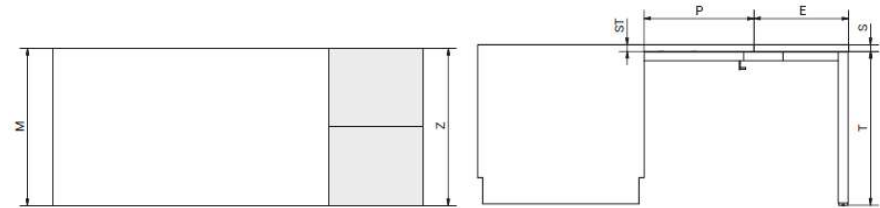

MODEL	CODICE ATIM	Description	M	P min	E	Z	S	ST	T	GAMBA/LEG	Цена с ДДС
VOILÁ CHAIR	411/78.1330.T	Mechanism + cover caps	700	800	650	700	18/20	18/20	710/735	72x45	2,403.36
VOILÁ CHAIR	411/78.1331.T	Mechanism + cover caps	700	900	650	800	18/20	18/20	710/735	72x45	2,403.36
VOILÁ CHAIR	411/78.1332.T	Mechanism + cover caps	700	1000	650	900	18/20	18/20	710/735	72x45	2,403.36
VOILÁ CHAIR	411/78.1333.T	Mechanism + cover caps	800	800	650	700	18/20	18/20	710/735	72x45	2,403.36
VOILÁ CHAIR	411/78.1334.T	Mechanism + cover caps	800	900	650	800	18/20	18/20	710/735	72x45	2,403.36
VOILÁ CHAIR	411/78.1335.T	Mechanism + cover caps	800	1000	650	900	18/20	18/20	710/735	72x45	2,403.36
VOILÁ CHAIR	411/78.1336.T	Mechanism + cover caps	900	800	650	700	18/20	18/20	710/735	72x45	2,403.36
VOILÁ CHAIR	411/78.1337.T	Mechanism + cover caps	900	900	650	800	18/20	18/20	710/735	72x45	2,403.36
VOILÁ CHAIR	411/78.1338.T	Mechanism + cover caps	900	1000	650	900	18/20	18/20	710/735	72x45	2,403.36

Measures expressed in millimetres

Video: https://youtu.be/-4RRdir_OQg

Img:



Technical drawing:

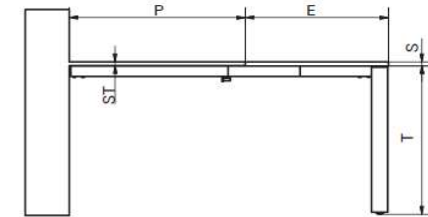
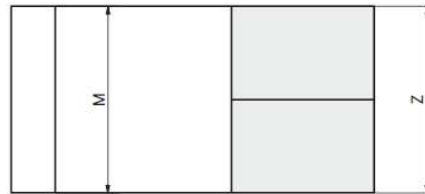

MODEL	CODICE ATIM	Description	M	P	Z	S	ST	E max	T	GAMBA/LEG	Цена с ДДС
VOILÁ CHAIR REVERSE	411/78.1320.T	Mechanism + cover caps	700	1100	700	18	18	1100	710/735	72x45	2,409.40
VOILÁ CHAIR REVERSE	411/78.1321.T	Mechanism + cover caps	700	1300	700	18	18	1300	710/735	72x45	2,409.40
VOILÁ CHAIR REVERSE	411/78.1322.T	Mechanism + cover caps	800	1100	800	18	18	1100	710/735	72x45	2,409.40
VOILÁ CHAIR REVERSE	411/78.1323.T	Mechanism + cover caps	800	1300	800	18	18	1300	710/735	72x45	2,409.40
VOILÁ CHAIR REVERSE	411/78.1324.T	Mechanism + cover caps	900	1100	900	18	18	1100	710/735	72x45	2,409.40
VOILÁ CHAIR REVERSE	411/78.1325.T	Mechanism + cover caps	900	1300	900	18	18	1300	710/735	72x45	2,409.40

Measures expressed in millimetres

Video: <https://youtu.be/O3eyLinoarY>

Img:



Technical drawing:

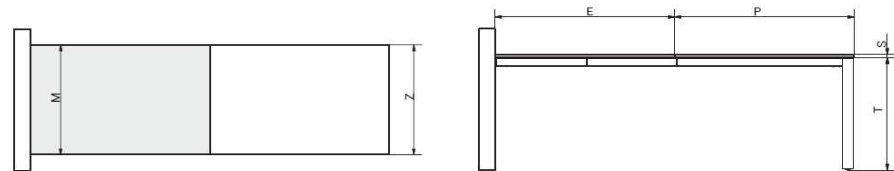

MODEL	CODICE ATIM	Description	M min	P min	H1	H min.	Z	Цена с ДДС
DINAMICO gola mm 4300 con Voilà Flag 800x800 > 1370x800 top mm 20	78.1192.25	Dinamico+ with mechanism, Gola profile, legs and extension	check the catalogue	check the catalogue	885	80	800	3,177.23
DINAMICO gola mm 4300 con Voilà Flag 800x800 > 1370x800 top mm 40	78.1193.25	Dinamico+ with mechanism, Gola profile, legs and extension	check the catalogue	check the catalogue	885	80	800	3,177.23
DINAMICO gola mm 4300 con 2 gambe HOP	411/78.1196.25	Dinamico+ with mechanism, Gola profile and legs	check the catalogue	check the catalogue	885	80	800	1,871.52
DINAMICO gola mm 4300	411/78.1301.25	Mechanism + gola profile	check the catalogue	check the catalogue	885	80	800	1,147.46
<i>Measures expressed in millimetres</i>								

Video:
https://youtu.be/_bpllhCPMM
Img:



Technical drawing:

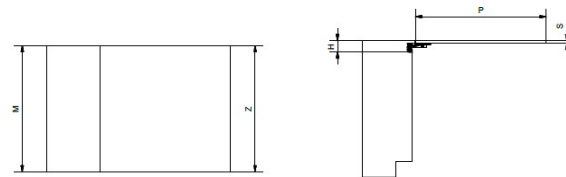

MODEL	CODICE ATIM	Description	P	L	T	H	E	E1	Z	S min	Price no leg	Цена с ДДС
SESTANTE	411/78.1290.22F	Mechanism	600	1500	930	50	900	300	600	18		2,295.65
SESTANTE	411/78.1291.22F	Mechanism	700	1500	930	50	900	400	700	18		2,295.65
SESTANTE	411/78.1292.22F	Mechanism	800	1500	930	50	900	500	800	18		2,333.38
SESTANTE	411/78.1293.22F	Mechanism	900	1500	930	50	900	600	900	18		2,333.38
SESTANTE	411/78.1294.22F	Mechanism	1200	1500	930	50	900	600	1200	18		2,371.11
SESTANTE	411/78.129X.22F	Mechanism	UNIVERSALE	1500	UNIVERSALE	50	900	da 300 a 600	UNIVERSALE	18	1,661.60	

Measures expressed in millimetres

Video: <https://youtu.be/l8DwJRb8P54>

Img:



Technical drawing:

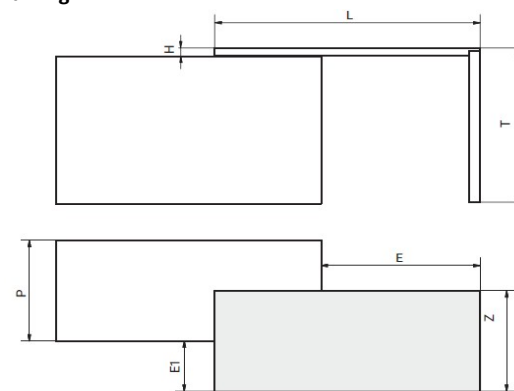

2.3052911.10 solo gamba regolabile

MODEL	CODICE ATIM	Description	M	P min	H min	S1	E	S min	Z min	T	Цена с ДДС
EVOLUTION +39	411/39.1610.T	Mechanism + cover caps	600	390	120	15/20	690	16	555	730/755	1,563.95
EVOLUTION +39	411/39.1611.T	Mechanism + cover caps	900	390	120	15/20	690	16	855	730/755	1,563.95
EVOLUTION +39	411/39.1612.T	Mechanism + cover caps	1200	390	120	15/20	690	16	1155	730/755	1,563.95
<i>Measures expressed in millimetres</i>											

Video: <https://youtu.be/RGCQNz0pT14>



Technical drawing:

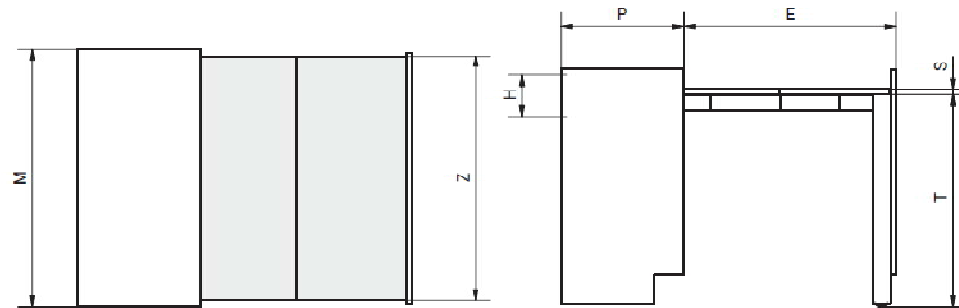

MODEL	CODICE ATIM	Description	M	P min	H min	S1	E	Z min	S min	T	Цена с ДДС	
EVOLUTION XL +39	411/39.1620.T	Mechanism + cover caps		600	520	150	15/20	1040	555	16	730/755	1,843.60
EVOLUTION XL +39	411/39.1621.T	Mechanism + cover caps		900	520	150	15/20	1040	855	16	730/755	1,843.60
EVOLUTION XL +39	411/39.1622.T	Mechanism + cover caps		1200	520	150	15/20	1040	1155	16	730/755	1,843.60

Video: <https://youtu.be/RGCQNz0pT14>

Img:



Technical drawing:

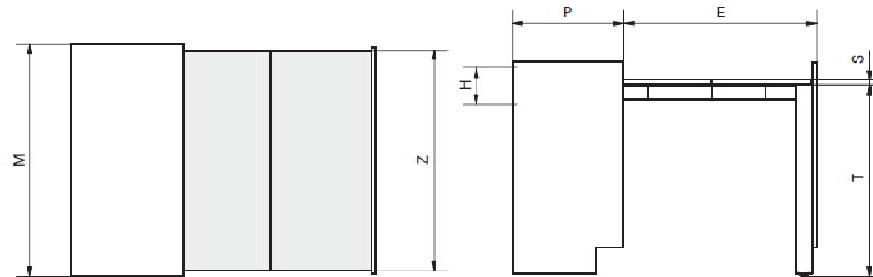

MODEL	CODICE ATIM	Description	M	P min	H	S1	E	Z min	S min	Цена с ДДС
HOMEWORK +39	411/39.1200.T	Mechanism + cover caps	600	390	54	15/20	1015	555	16	927.10
HOMEWORK +39	411/39.1210.T	Mechanism + cover caps	900	390	54	15/20	1015	855	16	927.10
HOMEWORK +39	411/39.1220.T	Mechanism + cover caps	1200	390	54	15/20	1015	1155	16	927.10
<i>Measures expressed in millimetres</i>										

Video: <https://youtu.be/RrEXGeiqCvY>

Img:



Technical drawing:

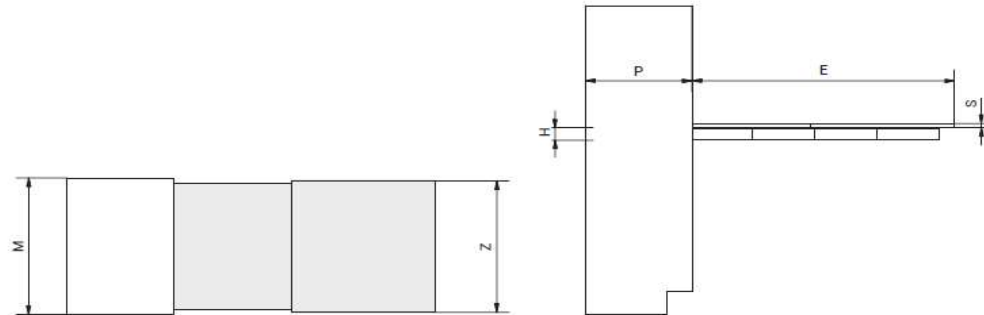

MODEL	CODICE ATIM	Description	M	P min	H min	S1	E	Z min	S min	Цена с ДДС
LUNCH +39	411/39.1100.T	Mechanism + cover caps	450/1200	390	120	15/20	705	405/1155	16	674.72
<i>Measures expressed in millimetres</i>										

Video: <https://youtu.be/ByS0U1BduuE>

Img:



Technical drawing:

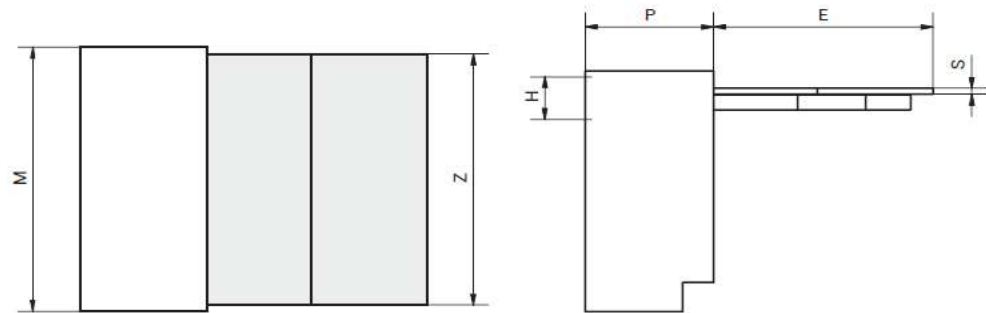

MODEL	CODICE ATIM	Description	M	P min	H min	S1	E	Z min	S min	T	Цена с ДДС
MENSOLA T-ABLE +39	411/39.1920.XT	Mechanism + cover caps	1200	390	180	15/20	1350	1155	14	712/737	1,470.47
<i>Measures expressed in millimetres</i>											

Video: <https://youtu.be/HoxTzHVkaH4>

Img:



Technical drawing:

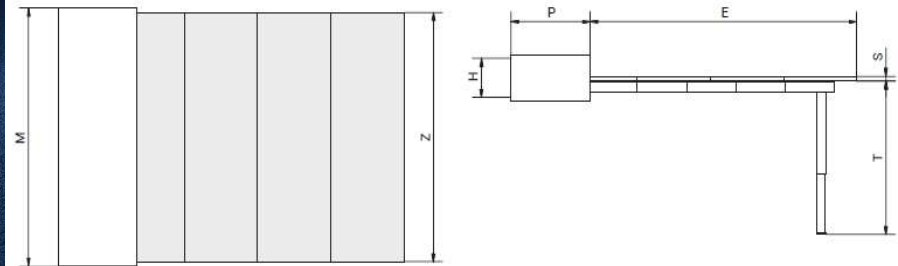

MODEL	CODICE ATIM	Description	M	P min	H min	S1	E	S	ST	Z	Цена с ДДС
OPLA' +39	411/39.1720.T	Mechanism + cover caps	450-1200	390	100	15/20	370	18/22	18/22	1155	749.93
<i>Measures expressed in millimetres</i>											

Video: <https://youtu.be/Nkk51XKxMTU>

Img:



Technical drawing:

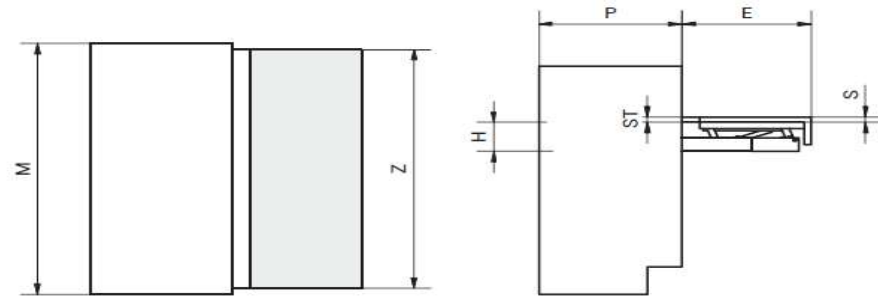

MODEL	CODICE ATIM	Description	M	P min	H min	S1	E	Z	S	ST	Цена с ДДС
OPLA' FOLDING +39	411/39.1700.FT	Mechanism + cover caps	450/1000	390	205	15/20	370	405/955	16/25	16/25	975.67
OPLA' FOLDING +39	411/39.1720.FT	Mechanism + cover caps	1200	390	205	15/20	370	1155	16/25	16/25	975.67
<i>Measures expressed in millimetres</i>											

Video: <https://youtu.be/JQlc72Az8BU>

Img:



Technical drawing:

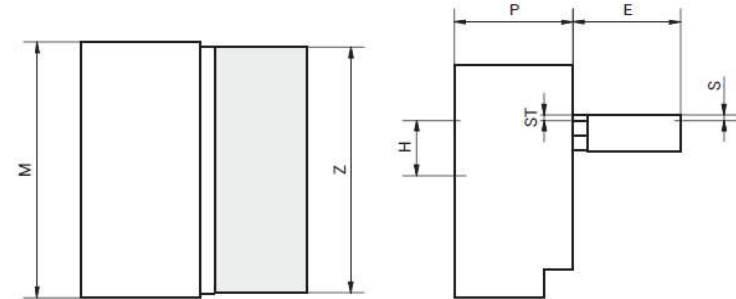

MODEL	CODICE ATIM	Description	M	P min	H min	S1	E	S min	Z min	T	Цена с ДДС
T-BENCH +39	411/39.1950.T	Mechanism + cover caps	450	390	120	15/20	705	16	405	395/420	1,111.37
T-BENCH +39	411/39.1960.T	Mechanism + cover caps	600	390	120	15/20	705	16	555	395/420	1,111.37
<i>Measures expressed in millimetres</i>											

Video: <https://youtu.be/O0dmFN-ei5g>

Img:



Technical drawing:

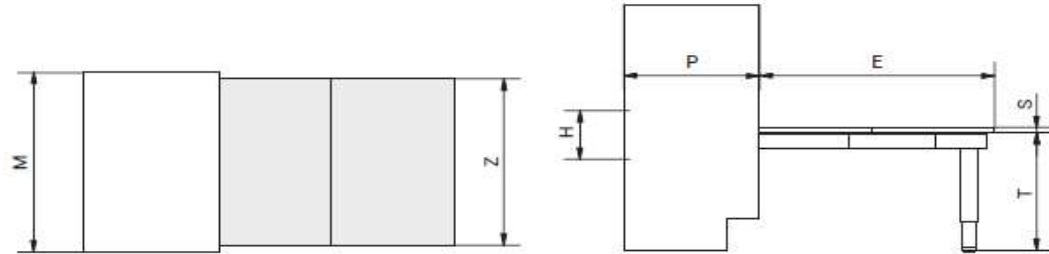

MODEL	CODICE ATIM	Description	M min	P min	H min	S1	E	Z min	S min	Цена с ДДС
SHOT +39	411/39.1130.25	Mechanism	450	390	90	15/20	325	405	16	516.77
SHOT +39	411/39.1130.25 F	Mechanism	450	390	90	15/20	325	405	16	516.77
SHOT +39	411/39.1130.T	Mechanism	450	390	90	15/20	325	405	16	534.88
SHOT +39	411/39.1130.FT	Mechanism	450	390	90	15/20	325	405	16	534.88
<i>Measures expressed in millimetres</i>										

Video: <https://youtu.be/Nkk51XKxMTU>

Img:



Technical drawing:

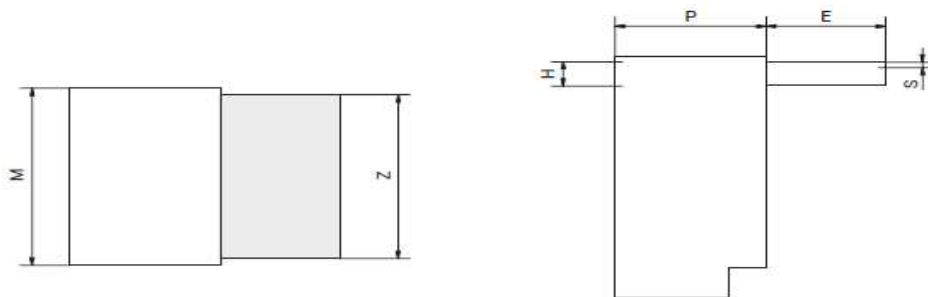

MODEL	CODICE ATIM	Description	M min	P min	H min	E	Z	Цена с ДДС
PRUA	411/78.1180.T	Mechanism + cover caps	360	535	150	885	350	1,139.36
PRUA SHORT	411/78.1181.T	Mechanism + cover caps	330	450	140	840	350	1,139.36
CAMBIO TELO								120.00

Measures expressed in millimetres

Video Prua: <https://youtu.be/yI5iTCKvDNs>

Video Prua

Short: <https://youtu.be/wAh9VC8Y1ZI>

Img:



Technical drawing:

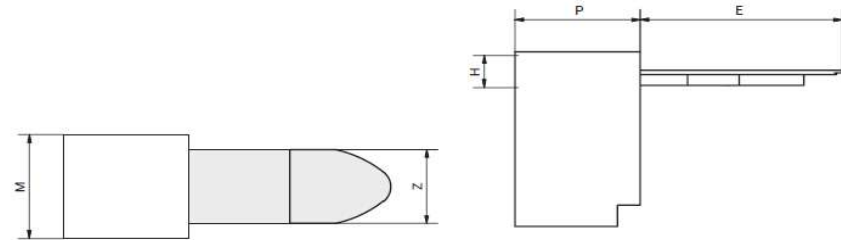

MODEL	CODICE ATIM	Description	M	P min	H min	S1	E	Z	T	Цена с ДДС
PRUA LIFT	411/78.1186.02	Mechanism	350	390	1100	15/20	1050	280	820	556.70
PRUA LIFT	411/78.1187.02	Mechanism	450	390	1100	15/20	1050	380	820	556.70
<i>Measures expressed in millimetres</i>										

Video: <https://youtu.be/ilmRrxvJE9E>

Img:

Technical drawing:

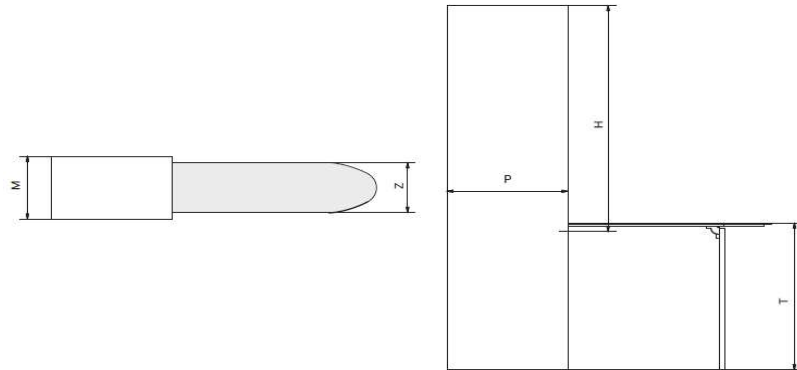

MODEL	CODICE ATIM	Description	M	P min.	H min.	Z	E	Цена с ДДС	Equipment
PRUA SWING	411/78.1182.22	Mechanism	1200	450	90	350	620	574.62	With wood panel and sheet
<i>Measures expressed in millimetres</i>									

Img:



Technical drawing:

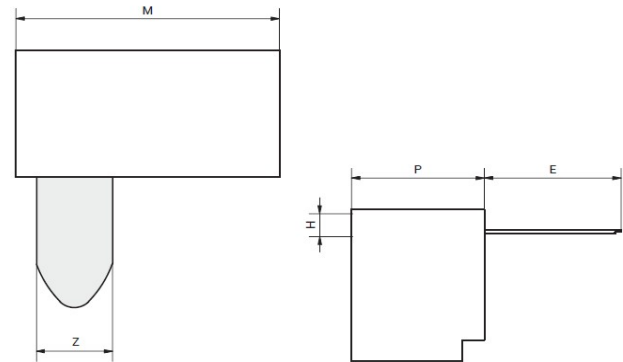

MODEL	CODICE ATIM	Description	M	P min	H min.	S1	E	Z	S min	Цена с ДДС	Equipment
BASKET <u>SILENT</u>	78.1183.T	Mechanism + cover caps	450	450	690	15/20	350	405	16	628.83	With sack without wood panel
BASKET <u>SILENT</u>	78.1184.T	Mechanism + cover caps	600	450	690	15/20	350	555	16	635.11	With sack without wood panel
BASKET <u>SILENT</u>	78.1185.T	Mechanism + cover caps	900	450	690	15/20	350	855	16	650.83	With sack without wood panel
BASKET <u>SILENT</u>	78.1186.T	Mechanism + cover caps	1200	450	690	15/20	350	1155	16	650.83	With sack without wood panel
BASKET <u>SILENT</u>	78.1183.25 P	Mechanism + woo hinged panel	450	450	690	15/20	350	405	16	950.02	With sack and wood panel
BASKET <u>SILENT</u>	78.1184.25 P	Mechanism + woo hinged panel	600	450	690	15/20	350	555	16	877.70	With sack and wood panel
BASKET <u>SILENT</u>	78.1185.25 P	Mechanism + woo hinged panel	900	450	690	15/20	350	855	16	928.01	With sack and wood panel
BASKET <u>SILENT</u>	78.1186.25 P	Mechanism + woo hinged panel	1200	450	690	15/20	350	1155	16	942.47	With sack and wood panel

Measures expressed in millimetres

Img:



Technical drawing:

